

# Estimation of Photovoltaic Hosting Capacity by Spatial Dependence on Adhesion of Consumers

Joel Villavicencio Gastelu, Ph.D<sup>1</sup>, Jonatas Boas Leite, Ph.D<sup>2</sup>, and Joel David Melo Trujillo, Ph.D<sup>3</sup>

<sup>1</sup>Universidad Tecnológica del Perú, Perú, joelitoilha@gmail.com, <sup>2</sup>UNESP - São Paulo State University, Brazil, jb.leite@unesp.br.com, <sup>3</sup>Federal University of ABC - UFABC, Brazil, joel.melo@ufabc.edu.br

**Abstract**– Photovoltaic (PV) hosting capacity studies usually consider uniform probability distribution to install PV by consumers. The history of PV installation in urban areas of several cities shows that the adhesion of PV in low-voltage (LV) networks has a spatial influence, i.e., the inhabitants' decision to install a PV system is influenced by their neighbors. This paper presents an alternative methodology to estimate PV hosting capacity (HC) by distribution transformers considering the spatial dependence on the adhesion of consumers. In the proposed method, the first law of geography is used to obtain the probabilities of installing PV by consumers considering their spatial influence. These probabilities provide the generation of diverse PV integration scenarios. The evaluation is performed using an LV feeder of a distribution company from São Paulo city in Brazil. A comparison with a uniform probability approach is also presented. Results indicate that the HC occurs at lower levels of PV penetration when spatial dependence is considered. Therefore, the proposed method can aid distribution companies in better characterizing PV penetration scenarios in HC studies.

**Keywords**– hosting capacity, photovoltaic integration, residential photovoltaic systems, spatial analysis

## I. INTRODUCTION

### A. Background and Problem Statement

Several studies have been conducted to estimate the maximum PV penetration that could be installed in an LV feeder before any operational limit is violated. These studies are known as hosting capacity (HC) studies. HC calculations are pivotal for distribution utilities, as it is a point from which network reinforcements will be necessary to accommodate more PV systems and guarantee energy quality.

The HC calculations employing a deterministic approach consider PV systems' locations and sizes are pre-established [1]. Moreover, the variability of load and PV generation is disregarded by only considering the worst scenario with low demand and high PV generation. Therefore, the deterministic approach does not consider the stochastic nature of the PV adhesion of consumers.

On the other hand, HC calculations that consider a stochastic approach takes into account the uncertainties of the future adoption of PV [2], [3]. In this approach, probability distributions allow the determination of PV systems' locations or sizes. Thus, the stochastic analysis generates several PV integration scenarios. However, it was noticed that the spatial dependence of PV adoption had been neglected, as it is presented below.

### B. Literature Review

HC calculations based on the stochastic approach commonly employ the Monte Carlo (MC) simulation, which uses probability distributions to include uncertainties. For instance, in [2] and [3], PV system nodes are selected randomly from a given list of candidate nodes using a uniform probability distribution. Additionally, in [2], PV systems' sizes are determined using a probability distribution obtained from the dataset of installed PV systems, whereas in [3], the sizes are pre-established. Finally, this process is repeated to obtain PV integration scenarios at higher values of PV penetration.

Besides the PV systems' location uncertainties, in [4], the phase connection, PV generation, and demand uncertainties are included in HC calculation. Similar to [2] and [3], the uniform probability distribution is assumed for PV locations and phase connections. Moreover, rectangular, or uniform probability distributions model the uncertainties such as PV generation and demand.

Other authors, such as in [5], considered consumers' socioeconomic characteristics in HC calculations. This information and economic indicators give the probability of PV installation, which helps determine the location and sizes of PV generators. However, factors such as the usable space on houses' roofs are not considered, which can result in unrealistic PV integration scenarios.

### C. Contribution

This paper presents an alternative methodology that considers the spatial dependence on consumers' adherence during calculating HC by distribution transformer. The spatial dependence is included through the first law of geography. Thus, the consumers' probabilities for installing a PV system depend on their distance from consumers with installed PV systems. These probabilities also consider the space on houses' roofs a favorable condition for PV adhesion by consumers. These probabilities allow the selection of a node from the LV feeder to install a PV system. Additionally, the PV system size is determined using statistical data from installed PV systems. Finally, the above process is repeated to generate PV integration scenarios in an LV feeder. It is expected to obtain scenarios with PV systems concentrated in some parts of the feeder by including spatial dependence. Therefore, the proposed method can better characterize the PV system adhesion by consumers compared to stochastic methods with uniform probabilities to install a PV system.

**Digital Object Identifier:** (only for full papers, inserted by LACCEI).

**ISSN, ISBN:** (to be inserted by LACCEI).

**DO NOT REMOVE**

## II. PROPOSED METHODOLOGY

The proposed methodology can estimate the HC by distribution transformer, generating PV system integration scenarios in LV feeders.

### A. Input Data

Input data are solar irradiance ( $\text{W}/\text{m}^2$ ), the usable area on rooftops for PV panel installation ( $\text{m}^2$ ), the number of consumers connected to an LV feeder, and the distance matrix among consumers.

Solar irradiance information is obtained from satellite images or weather stations. In addition, solar resource data can be found on several websites, such as [6] and [7]. For instance, in [7], solar data is available for the United States and several international regions and countries. Solar information is also available in commercial and open-source software, such as the PVsyst [8] and System Advisor Model software [9].

For residential PV systems, PV panels are usually placed on rooftops. The rooftop area is estimated in the specialized literature using statistical data and reduction factors [10], aerial images [11], or LiDAR [19]. This roof area can also be estimated from a land parcel and the characteristics of the roofed area. The method presented in [13] is considered when calculating usable space for PV panel installation.

The network's topology is available information for most utilities. From this information, the number of consumers and their locations in an LV feeder can be retrieved. Furthermore, the consumers' distance matrix can be obtained from consumers' locations. This matrix contains the distance between whichever two consumers.

### B. PV Installation Probabilities by the Spatial Dependence on Adhesion of Consumers

The consumers' decision to install a PV system depends on several factors, including the availability of space on their roof and their energy consumption [14]. Roofed area and energy consumption are information available for utilities. A consumer with a usable roof area and relatively high energy consumption has favorable conditions for installing a PV system. As higher the usable area and the energy consumption, the higher the applicable requirements for installing a PV system.

Another factor influencing consumers' decision to install a PV system is the social interaction among near consumers. In [14] and [15], it is reported that peer effects influence the PV adhesion of consumers. This peer effect represents the influence consumers with a PV system have over consumers without a PV system. According to [15], consumers living nearby tend to present similar behavior, including their tendency to acquire new technologies, such as a PV system [16].

For the determination of the first PV adopter, it is considered that neighbors do not influence his decision once one has already installed a PV system. In this case, his decision is mainly influenced by his favorable conditions for installing a PV system. Thus, during the determination of the first PV

adopter, the PV installation probability at node  $i$  is calculated using (1)

$$p_i = \frac{\sum_{k \in \mathbf{A}} \omega_k f_{k,i}}{R}, \forall i \in \mathbf{\Omega}. \quad (1)$$

where  $\mathbf{A} = \{1, 2, \dots, n_A\}$  is the set of favorable conditions considered in the analysis. The set  $\mathbf{\Omega}$  contains the candidate nodes of the network where it is possible to install a PV system. The value of the favorable condition  $k$  is given by  $f_{k,i}$ . The weights  $\omega_k$  measure the importance of the favorable condition  $k$  in the consumer's decision to install a PV system. The  $R$  factor is a normalization value for probabilities; therefore, the  $R$ -value is not necessarily a fixed value.

The first law of geography is used to consider the peer effects. Events occurring in nearby locations are more similar to those occurring in faraway places [17]. Therefore, the proposed methodology considers these peer effects by including the distance among consumers. For the determination of the next PV adopters (from the second one to the last one), the PV installation probability at node  $i$  is computed using (2).

$$p_i = \frac{1}{R} \frac{\sum_{k \in \mathbf{A}} \omega_k f_{k,i}}{\sum_{j \in \mathbf{B}} d_{i,j}^2}, \forall i \in \mathbf{\Omega}. \quad (2)$$

where  $d_{i,j}$  is the distance between a node with a PV system and another without a PV system,  $\mathbf{B}$  is the set of nodes with installed PV system, while the other terms are the same as given in (1). Note that  $\mathbf{\Omega}$  and  $\mathbf{B}$  must be updated each time a new consumer to install a PV system is selected.

### C. PV System Integration in LV Feeders

Once the PV installation probabilities are obtained, it cannot be affirmed that the consumer with the highest probability calculated using (1) will be the first to install a PV system. The same applies to the next consumers (from the second one to the last one), for which consumers' PV installation probabilities are computed using (2). Such installation probabilities just mean higher fitness for PV adhesion. This way, a stochastic selection algorithm is used to determine consumers to install a PV system. Consumers' fitness is equal to their PV installation probabilities. The integration of a PV system in an LV feeder is performed in two steps.

**Step 1:** A roulette wheel selection is employed to determine consumers that will install a PV system. The probabilities described in Section II-B are used as consumers' fitness for PV installation. This fitness is given by (1) for determining the first PV adopter and (2) for the next.

**Step 2:** The size of the consumer's PV system selected in Step 1 is also chosen using a roulette wheel selection. However, in this case, the probability distribution is obtained using statistics from installed PV systems capacities in a broader geographical area (such as a city) that contain the LV feeder under study. This probability is used as PV system sizes' fitness.

The above steps are repeated to include more PV systems in the LV feeder. How consumers with installed PV systems

populate the nodes of an LV feeder is called a PV system integration scenario.

#### D. PV Hosting Capacity by Transformer

HC is the highest PV penetration that does not result in any operational limit violation. Several definitions of PV penetration have been used in the specialized literature. The total installed power is considered as the PV penetration in [5], while in [18], the PV penetration is the ratio of PV peak power to maximum network load [19]. The authors in [20] and [21] define PV penetration as the ratio of the total installed PV capacity of the network and the feeding transformer's capacity. Other authors, such as in [22], consider PV penetration as the ratio of consumers with PV systems and the total number of consumers. Thus, for an LV feeder with PV systems, the level of PV penetration,  $\alpha$ , is computed using (3).

$$\alpha = \frac{N^{PV}}{N}. \quad (3)$$

where  $N^{PV}$  is the number of consumers with a PV system and  $N$  is the total number of consumers.

In HC studies, the operational limits, such as voltage, transformer loading, transformer power factor, etc., must be first specified [23]. The voltage upper limit is usually considered because previous works found that overvoltage is the most critical technical problem in LV networks with high PV penetration [20].

Another characteristic that must be specified in HC calculation is the simulation time step. This time step depends mainly on data availability. For example, solar data is commonly available for one hour or 30 minutes. Another factor influencing the decision for a particular simulation resolution is the operational limit under study. For instance, if only the overvoltage is of interest, one can consider one-hour power flow simulations.

The flowchart in Fig. 1 shows the steps for calculating the HC of a PV system integration scenario.

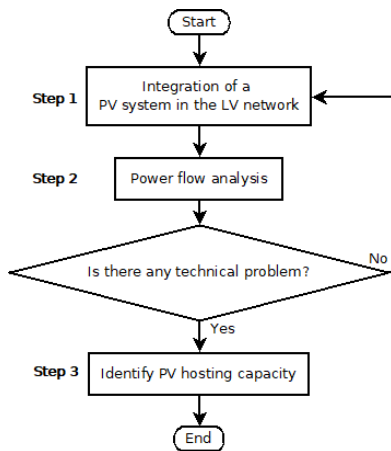

Fig. 1 Flowchart for estimating HC in LV networks.

**Step 1:** A consumer is selected to install a PV system as Section II-C.

**Step 2:** power flow simulations are performed to obtain an operational parameter (such as voltage) of the network along a specified period.

The results obtained in step 2 are checked at each simulation time step to identify any operational limit violation. If at the end of the specified period, there is no violation, steps 1 and 2 are repeated. Otherwise, go to Step 3.

**Step 3:** The PV penetration is calculated using (3) once any operational limit violation is observed. The HC is equal to the corresponding last PV penetration without any operational limit violation.

The sensitivity analysis performed in [20] indicates that using 50 scenarios is sufficient for convergence criteria. Here, the criterion for determining the total number of scenarios is to obtain changes in the average HC results of PV integration scenarios lower than or equal to 5% compared to those obtained considering more scenarios.

### III. RESULTS AND DISCUSSIONS

In Brazil, after the normative resolutions 482 [24] and 687 [25], the constant growth of residential PV system have been observed [26]. Because of this growth, utilities are interested in determining the HC by distribution transformers. Therefore, the proposed methodology is applied to the LV feeder of a distribution transformer in Sao Paulo, Brazil. Fig. 2 shows the topology of the LV feeder.

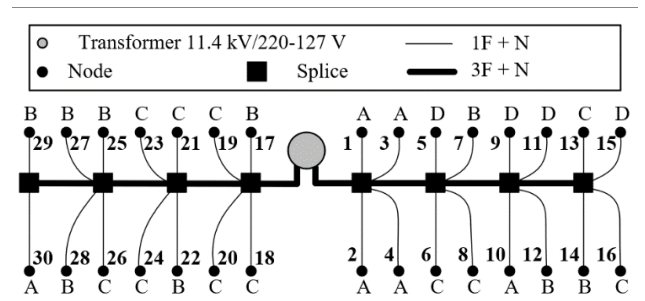

Fig. 2 The LV network under study

The four types of demand profiles shown in Fig. 3 were identified. These profiles were obtained using data from consumers' energy meters and the methodology presented in [27].

PV generation is obtained using the mathematical model for PV systems presented in [28] and information on solar irradiance and ambient temperature. The PV system's capacity used in simulations is taken from the most common installed capacity in the city. Fig. 4 shows the PV systems' generation curve for these capacities. Statistics of installed PV systems in Brazilian cities can be found in [29].

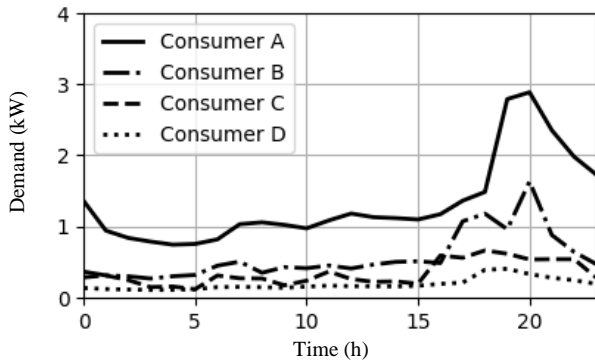

Fig. 3 The consumers' demand profile

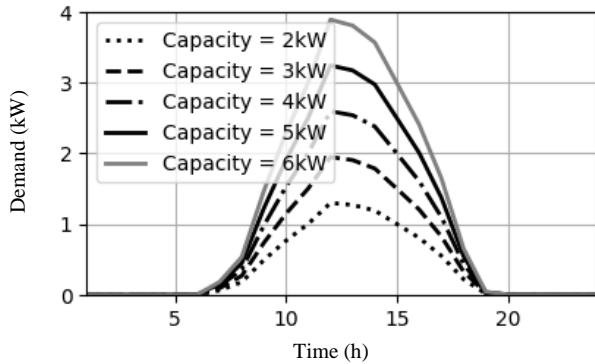

Fig. 4 The PV generation curve

The HC of the distribution transformer was determined using the above information, considering the overvoltage in the LV feeder as the operational limit (1.05 p.u. [30]). To this end, hourly power flow simulations were conducted, considering that all PV systems are subjected to the same solar irradiance.

#### A. Results

Fig. 5 shows the average of HC as a function of the number of scenarios. Each curve in this figure represents the average result for 200 PV integration scenarios generated by the proposed methodology.

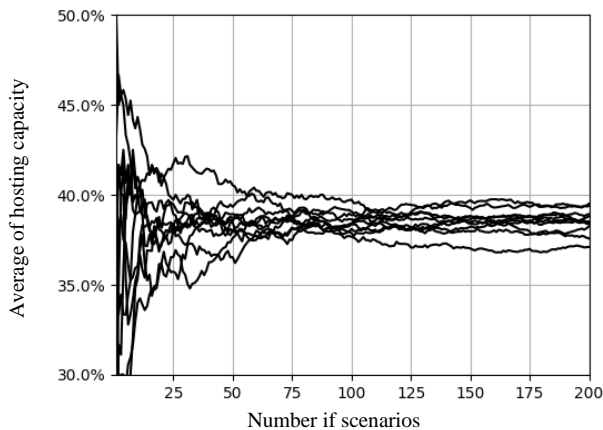

Fig. 5 Average of hosting capacity as a function of the number of scenarios

Results indicate that considering 100 or more scenarios is sufficient to obtain a variation lower than 5% of the average of HC. Therefore, in the following results, only 100 scenarios were considered for any set of PV integration scenarios.

Fig. 6 shows the frequency of HC for a set of PV integration scenarios.

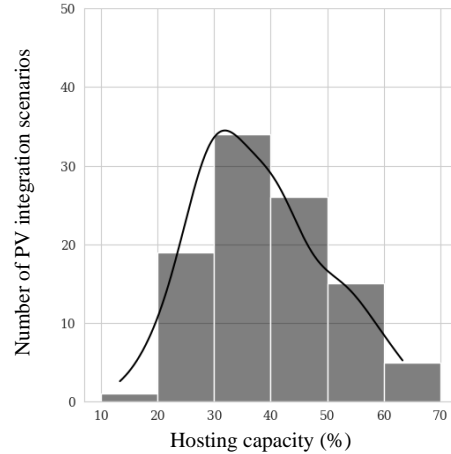

Fig. 6 The frequency distribution of HC obtained considering the spatial dependence of PV integration.

Obtained values of HC range from 13.33% to 63.33%. Also, it is observed that in most PV integration scenarios, the HC is about 30%. Similar results to those presented in Fig. 6 were obtained for other sets of PV integration scenarios.

#### B. Discussion

A typical methodology used in the specialized literature for generating PV integration scenarios is considered for discussion purposes. This methodology is also a Monte Carlo simulation, in which all consumers have the same probability of installing a PV system [31]. Fig. 7 shows the frequency of HC of a set of PV integration scenarios considering this methodology.

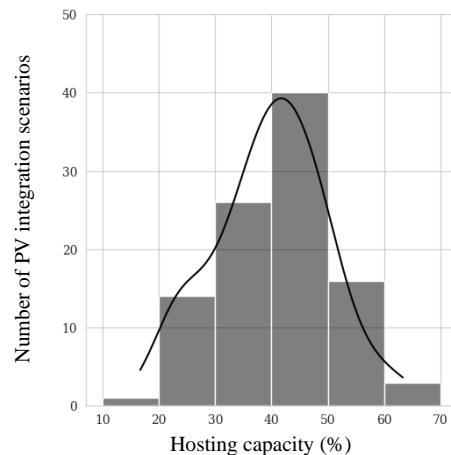

Fig. 7 The frequency distribution of HC obtained using MC simulation with a uniform probability distribution.

Fig 7 shows HC ranges from 16.67% to 63.33%. Most PV integration scenarios result in an HC of about 40%. Since probabilities are also considered in the typical methodology, similar HC results are obtained for other sets of PV integration scenarios. Results shown in Fig. 6 and 7 indicate that the inclusion of the spatial dependence of PV adoption reduces the HC by 10%.

The voltage rise is caused by higher PV generation whenever consumers with PV systems are grouped and located far from a distribution transformer. The tendency to a high frequency of low HC values obtained by the proposed method is due to our approach generating more PV integration scenarios with the concentration of PV systems in some parts of the LV feeder. Moreover, the lower HC values correspond to scenarios where consumers with PV systems are located near the distribution transformer. These findings are useful for distribution companies as the HC value indicates the level of PV penetration from which actions must be taken.

#### IV. CONCLUSION

An alternative methodology for HC estimations by distribution transformer was presented. This paper's significant contribution is considering favorable conditions for installing PV systems and the spatial dependence of PV integration in LV feeders.

The proposed methodology results in lower values of HC than those obtained using a methodology that considers uniform probabilities during the generation of PV integration scenarios. These results suggest that utilities should begin implementing mitigation techniques at lower values of PV penetration.

#### ACKNOWLEDGMENT

This study was financed by Programa de Incentivos a las Publicaciones Científicas de la Universidad Tecnológica del Perú; by Coordenação de Aperfeiçoamento de Pessoal de Nível Superior - Brazil (CAPES) - Finance Code 001; by São Paulo Research Foundation - Brazil (FAPESP) under grants: 2015/21972-6, 2019/00466-6, 2019/07436-5 and 2021/08832-1; by Conselho Nacional de Desenvolvimento Científico e Tecnológico - Brazil (CNPq) undergrant: 422044/2018-0, 310299/2020-9 and 408898/2021-6; and by Instituto Nacional de Ciência e Tecnologia de Energia Elétrica - Brazil (INCT-ENERGE). The authors also want to thank the Consejo Nacional de Ciencia, Tecnología e Innovación Tecnológica - Peru (CONCYTEC) for the access to papers published in international journals.

#### REFERENCES

[1] P. Westacott and C. Candelise, "Assessing the impacts of photovoltaic penetration across an entire low-voltage distribution network containing 1.5 million customers," *IET Renew. Power Gener.*, vol. 10, no. 4, pp. 460–466, 2016, doi: 10.1049/iet-rpg.2015.0535.

[2] F. Ding and B. Mather, "On Distributed PV Hosting Capacity Estimation, Sensitivity Study, and Improvement," *IEEE Trans. Sustain. Energy*, vol. 8, no. 3, pp. 1010–1020, 2017, doi: 10.1109/TSTE.2016.2640239.

[3] M. H. J. Bollen and S. K. Rönnerberg, "Hosting capacity of the power grid

for renewable electricity production and new large consumption equipment," *Energies*, vol. 10, no. 9, 2017, doi: 10.3390/en10091325.

[4] E. Mulenga, M. H. J. Bollen, and N. Etherden, "Solar PV stochastic hosting capacity in distribution networks considering aleatory and epistemic uncertainties," *Int. J. Electr. Power Energy Syst.*, vol. 130, no. July 2020, p. 106928, Sep. 2021, doi: 10.1016/j.ijepes.2021.106928.

[5] A. Arguello, J. D. Lara, J. D. Rojas, and G. Valverde, "Impact of Rooftop PV Integration in Distribution Systems Considering Socioeconomic Factors," *IEEE Syst. J.*, vol. 12, no. 4, pp. 3531–3542, 2018, doi: 10.1109/JSYST.2017.2739022.

[6] SOLARGIS, "Solar resource maps and GIS data for 200+ countries | Solargis." <https://solargis.com/maps-and-gis-data/download> (accessed Apr. 14, 2022).

[7] N. National Renewable Energy Laboratory, "National Solar Radiation Database Data Viewer." [https://maps.nrel.gov/nsrdb-viewer/?aL=x8CI3i%255Bv%255D%3Dt%26Jea8x6%255Bv%255D%3Dt%26Jea8x6%255Bd%255D%3D1%26VRLt\\_G%255Bv%255D%3Dt%26VRLt\\_G%255Bd%255D%3D2%26mcQtmw%255Bv%255D%3Dt%26mcQtmw%255Bd%255D%3D3&bL=clight&cE=0&lR=0&mC=4.740675384778373%2C22.8515](https://maps.nrel.gov/nsrdb-viewer/?aL=x8CI3i%255Bv%255D%3Dt%26Jea8x6%255Bv%255D%3Dt%26Jea8x6%255Bd%255D%3D1%26VRLt_G%255Bv%255D%3Dt%26VRLt_G%255Bd%255D%3D2%26mcQtmw%255Bv%255D%3Dt%26mcQtmw%255Bd%255D%3D3&bL=clight&cE=0&lR=0&mC=4.740675384778373%2C22.8515) (accessed Apr. 14, 2022).

[8] PVsyst team, "PVsyst – Logiciel Photovoltaïque." <https://www.pvsyst.com/> (accessed Apr. 14, 2022).

[9] N. National Renewable Energy Laboratory, "Home - System Advisor Model (SAM)." <https://sam.nrel.gov/> (accessed Apr. 14, 2022).

[10] R. F. C. Miranda, A. Szklo, and R. Schaeffer, "Technical-economic potential of PV systems on Brazilian rooftops," *Renew. Energy*, vol. 75, no. December 2012, pp. 694–713, 2015, doi: 10.1016/j.renene.2014.10.037.

[11] C. Zhang, Z. Li, H. Jiang, Y. Luo, and S. Xu, "Deep learning method for evaluating photovoltaic potential of urban land-use: A case study of Wuhan, China," *Appl. Energy*, no. November, p. 116329, Dec. 2020, doi: 10.1016/j.apenergy.2020.116329.

[12] T. N. C. de Vries *et al.*, "A quick-scan method to assess photovoltaic rooftop potential based on aerial imagery and LiDAR," *Sol. Energy*, vol. 209, no. July, pp. 96–107, Oct. 2020, doi: 10.1016/j.solener.2020.07.035.

[13] J. V. Gastelu, V. G. Borges, and J. D. M. Trujillo, "Photovoltaic Potential Spatial Estimation Considering Shading Effects," in *2021 IEEE PES Innovative Smart Grid Technologies Conference - Latin America (ISGT Latin America)*, Sep. 2021, pp. 1–5, doi: 10.1109/ISGTLatinAmerica52371.2021.9543075.

[14] J. Müller and E. Trutnevyte, "Spatial projections of solar PV installations at subnational level: Accuracy testing of regression models," *Appl. Energy*, vol. 265, no. September 2019, p. 114747, May 2020, doi: 10.1016/j.apenergy.2020.114747.

[15] M. Graziano, M. Fiaschetti, and C. Atkinson-Palombo, "Peer effects in the adoption of solar energy technologies in the United States: An urban case study," *Energy Res. Soc. Sci.*, vol. 48, no. September 2018, pp. 75–84, Feb. 2019, doi: 10.1016/j.erss.2018.09.002.

[16] D. Marcochi de Melo, J. V. Gastelu, P. T. L. Asano, and J. D. Melo, "Spatiotemporal estimation of photovoltaic system adopters using fuzzy logic," *Renew. Energy*, vol. 181, pp. 1188–1196, Sep. 2021, doi: 10.1016/j.renene.2021.09.113.

[17] J. Gao, *Fundamentals of Spatial Analysis and Modelling*, First edition. Boca Raton: CRC Press, 2021.

[18] A. Arshad, M. Lindner, and M. Lehtonen, "An analysis of photo-voltaic hosting capacity in finnish low voltage distribution networks," *Energies*, vol. 10, no. 11, 2017, doi: 10.3390/en10111702.

[19] C. T. Gaunt, E. Namanya, and R. Herman, "Voltage modelling of LV feeders with dispersed generation: Limits of penetration of randomly connected photovoltaic generation," *Electr. Power Syst. Res.*, vol. 143,

- pp. 1–6, 2017, doi: 10.1016/j.epr.2016.08.042.
- [20] R. Torquato, D. Salles, C. Oriente Pereira, P. C. M. Meira, and W. Freitas, “A Comprehensive Assessment of PV Hosting Capacity on Low-Voltage Distribution Systems,” *IEEE Trans. Power Deliv.*, vol. 33, no. 2, pp. 1002–1012, Apr. 2018, doi: 10.1109/TPWRD.2018.2798707.
- [21] A. Arshad and M. Lehtonen, “A Stochastic Assessment of PV Hosting Capacity Enhancement in Distribution Network Utilizing Voltage Support Techniques,” *IEEE Access*, vol. 7, pp. 1–1, 2019, doi: 10.1109/ACCESS.2019.2908725.
- [22] A. Molin, S. Schneider, P. Rohdin, and B. Moshfegh, “Assessing a regional building applied PV potential - Spatial and dynamic analysis of supply and load matching,” *Renew. Energy*, vol. 91, pp. 261–274, 2016, doi: 10.1016/j.renene.2016.01.084.
- [23] M. Zain ul Abideen, O. Ellabban, and L. Al-Fagih, “A Review of the Tools and Methods for Distribution Networks’ Hosting Capacity Calculation,” *Energies*, vol. 13, no. 11, p. 2758, Jun. 2020, doi: 10.3390/en13112758.
- [24] Agência Nacional de Energia Elétrica - ANEEL, *Resolução normativa Nº 482, de 17 DE abril de 2012*. Brazil, 2012, p. 13.
- [25] Agência Nacional de Energia Elétrica - ANEEL, *Resolução Normativa nº 687 de 2015 da ANEEL*. 2015, p. 24.
- [26] IEA, “Renewables 2021 Data Explorer – Data Tools - IEA,” 2022. <https://www.iea.org/data-and-statistics/data-tools/renewables-2021-data-explorer?mode=market&region=Brazil&publication=2021&product=PV+residential+systems> (accessed Oct. 25, 2022).
- [27] J. A. Jardini, C. M. V. Tahan, M. R. Gouvea, S. U. Ahn, and F. M. Figueiredo, “Daily load profiles for residential, commercial and industrial low voltage consumers,” *IEEE Trans. Power Deliv.*, vol. 15, no. 1, pp. 375–380, 2002, doi: 10.1109/61.847276.
- [28] P. Radatz, C. Rocha, W. Sunderman, M. Rylander, and J. Peppanen, “OpenDSS PVSystem and InvControl Element Models,” California, 2020. [Online]. Available: <http://svn.code.sf.net/p/electricdss/code/trunk/Distrib/Doc/>.
- [29] Agência Nacional de Energia Elétrica - ANEEL, “Geração Distribuída,” 2022. <https://app.powerbi.com/view?r=eyJrIjoiY2VmMmUwN2QtYWFiOS00ZDE3LWl3NDMtZDk0NGI4MGU2NTkxIiwidCI6IjQwZDZmOWI4LWVjYjYtNDZhMi05MmQ0LWVhNGU5YzAxNzBiMSIsImMiOiR9> (accessed Nov. 08, 2022).
- [30] Agência Nacional de Energia Elétrica - ANEEL, *Procedimentos de Distribuição de Energia Elétrica no Sistema Elétrico Nacional – PRODIST Módulo 8 – Qualidade do fornecimento de energia elétrica*. Brazil, 2022, pp. 64–65.
- [31] A. Dubey and S. Santoso, “On Estimation and Sensitivity Analysis of Distribution Circuit’s Photovoltaic Hosting Capacity,” *IEEE Trans. Power Syst.*, vol. 32, no. 4, pp. 2779–2789, 2017, doi: 10.1109/TPWRS.2016.2622286.