







Application of the Identification and Emulation of SISO Systems in Industrial Plants with a Portable System

Leonardo Vinces, Doctor¹, Santiago Rubiños, Doctor², Eduardo Chavez, Bachiller³, Herbert Grados, Doctor⁴, Antenor Leva, Doctor⁵, Marcelo Damas, Doctor⁶ and Cesar Santos, Doctor⁷

^{1,2,3,4,5,6,7}Universidad Nacional del Callao, Perú, lvincesgs@unac.edu.pe, lrubinosj@unac.edu.pe, enchavezg@unac.edu.pe, hjgradose@unac.edu.pe, alevaa@unac.edu.pe, mndamasn@unac.edu.pe, csantosm@unac.edu.pe

Abstract— The present research work includes the development of a portable system for the identification and emulation of Single Input Single Output (SISO) systems, the identification process was carried out through the open loop strategy using the Strejc Method, through this method the identification was achieved by calculating the slope maximum and their respective crossings with the axes. SISO type systems up to order 5 were identified. For the emulation process, the Tustin approximation method was used, to obtain a system of difference equations, then the values are sent to a Digital-Analog converter and the transfer function up to order 5. Under this Hardware in-the-Loop (HIL) configuration, where it interacts with a control system, such as stand-alone controllers up to high-end controllers. Where the process controller will be an Industrial Controller and as an emulated component will be the mathematical models in continuous or discrete systems of the plant model.

Keywords—SISO, industrial plants, emulation process, Portable System.

Digital Object Identifier: (only for full papers, inserted by LACCEI).
ISSN, ISBN: (to be inserted by LACCEI).
DO NOT REMOVE

Application of the Identification and Emulation of SISO Systems in Industrial Plants with a Portable System

Leonardo Vincés, Doctor¹, Santiago Rubiños, Doctor², Eduardo Chavez, Bachiller³, Herbert Grados, Doctor⁴, Antenor Leva, Doctor⁵, Marcelo Damas, Doctor⁶ and Cesar Santos, Doctor⁷,
^{1,2,3,4,5,6,7}Universidad Nacional del Callao, Perú, lvincesgs@unac.edu.pe, lrubinosj@unac.edu.pe,
enchavezg@unac.edu.pe, hjgradose@unac.edu.pe, alevaa@unac.edu.pe, mndamasn@unac.edu.pe,
csantosm@unac.edu.pe

Abstract– The present research work includes the development of a portable system for the identification and emulation of SISO systems, the identification process was carried out through the open loop strategy using the Strejc Method, through this method the identification was achieved by calculating the slope maximum and their respective crossings with the axes. SISO type systems up to order 5 were identified. For the emulation process, the Tustin approximation method was used, to obtain a system of difference equations, then the values are sent to a Digital-Analog converter and the transfer function up to order 5. Under this Hardware in-the-Loop (HIL) configuration, where it interacts with a control system, such as stand-alone controllers up to high-end controllers. Where the process controller will be an Industrial Controller and as an emulated component will be the mathematical models in continuous or discrete systems of the plant model.

Keywords– SISO, industrial plants, emulation process, Portable System.

I. INTRODUCTION (HEADING 1)

Competition at the industrial level gave rise to the improvement and optimization of control techniques, looking for new strategies that help solve problems such as: processes with complex dynamics and variables over time, with multiple variables, delays, restrictions and disturbances that sometimes they are treated inefficiently [1]. In advance, it is known that control laws are essential in the industry, because today automation within industries is advancing more and more [2]. The vast amount of control research and many control applications that have been reported in recent years have focused on system control, making it widely used in various applications including medicine, business, energy usage and science [3]. Modern control engineering theory is a subfield of applied mathematics that is based on the use of new control design strategies to improve system performance and efficiency [4]. Determining the dynamic behavior of a given system involves the derivation of equations that are based on the mathematical relationship between the properties of the system. In the case of Damodaran, I use this technique to control a two-wheeled mobile robot and Ramírez to control a pneumatic servo positioning system. [5].

To increase the competitiveness of the processes, it has been necessary to use techniques: methods and tools that allow maximizing the efficiency of the systems, developing quality

controllers, since currently different types of tests must be carried out, which can generate, damages, losses and delays, therefore, the flexibility of the processes must be increased with the least adjustment of the machine, this implies knowing the dynamic behavior of the process [6]. The Strejc method is used for the identification of the multiple pole system from parameters obtained from the response to a step-type input [7] and the Tustin method is also known as bilinear transform, it corresponds to a tool similar to the method of Euler, but more precise in the estimation of the differential equations that model the behavior of the system [8]. The Tustin method is used to discretize the transfer function of continuous time controllers with transformations known as bilinear, that is, they change from the s to Z plane and vice versa [9].

For this reason, the present investigation has as its main objective the development of an portable system, which can carry out the identification with the Strejc method and subsequent emulation of a SISO system up to order 5 with the Tustin approximation method, this tool will allow us to considerably reduce the start-up times of a plant, as well as the reduction of times for the identification of the systems.

II. METHOD

For the identification process of SISO type systems with multiple poles, the Strejc method will be applied, which consists of a graphic method where a straight line of maximum slope is drawn, which will be superimposed on the slope area of the system. to identify, in such a way that the parameter Tu is obtained with the cut of the abscissa axis and the value of the parameter Ta is obtained with the cut of a parallel to the abscissa axis at the point where the response is stable [10] and for the transfer function emulation process, the Tustin approximation is used, which preserves the stability of the original transfer function, that is, if it is stable, the approximate one will also be stable and vice versa [11].

General System:

It should be noted that there are several stages in the present investigation. All parts of the implemented system share among themselves various types of technology. In such a

way that the following block diagram shows the implemented embedded system.

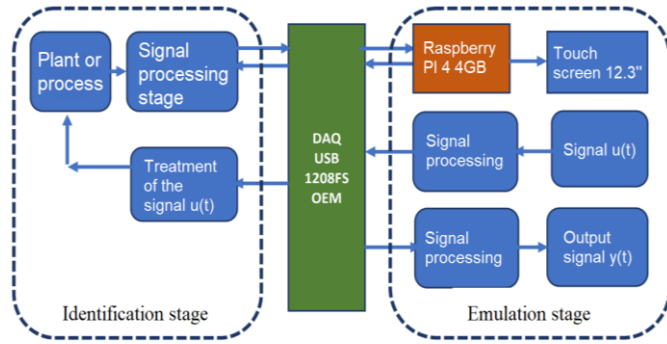

Fig. 1 Block diagram of the investigation

Next, each of the stages of the research work are described, in each one of them they detail the principle of operation, stages of conditioning, processing, algorithms and visualization of the different signals.

A. System identification stage

1) *Input signal conditioning stage $u(t)$* : In this stage, the output signal $u(t)$ is generated for excitation of the system or process to be identified. In this sense, there is a stage for conditioning the output signal of the acquisition card at voltage and current levels most used in the industry. It is possible to obtain the transfer function by applying an input signal known as the step signal and analyzing the type of curve of the output signal [12]. The plant can be excited, in order to obtain the characteristic curve of the system to be identified. Next, Figure 2 shows the block diagram of the stage in question.

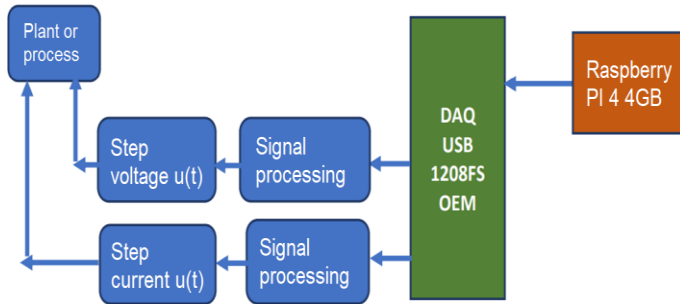

Fig. 2 Block diagram of the identification system

This stage also consists of an electronic circuit which performs the function of voltage follower and conditioner, a signal conditioner allows amplifying a voltage or current at the established levels of 0-10v or 4-20mA [13]. These signals usually represent physical magnitudes of the process, such as pressure, temperature, speed, level, etc. [14].

For the current $u(t)$ signal, we have the following electronic design (see figure 3).

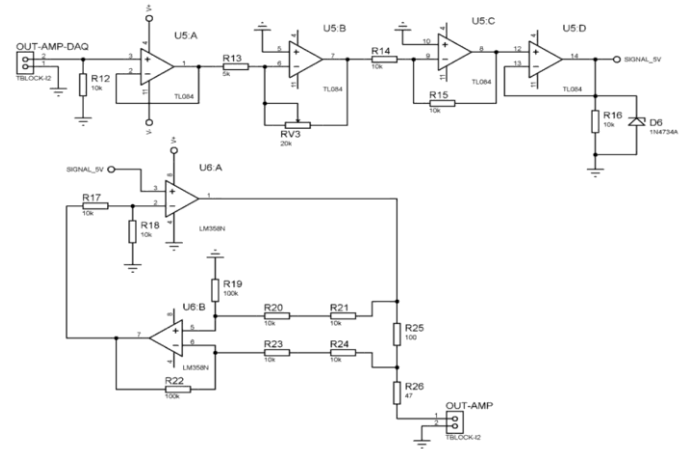

Fig. 3 Current $u(t)$ conditioning circuit (4-20mA) For the $u(t)$ signal in voltage (see figure 4).

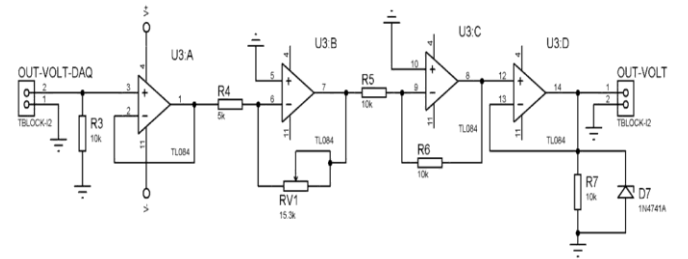

Fig. 4 Conditioning circuit of $u(t)$ in voltage (0-10V)

2) *Conditioning stage of the output signal of the original system*: After the excitation stage of the system, this output must be sensed in terms of voltage or current level depending on the type of variable. Once the signal was captured at the levels indicated above, an electronic conditioning circuit was designed, with the intention that this signal can be digitized by the data acquisition card, since the Raspberry PI requires that its programming be discrete, we use the equation (1) that presents the bilinear transformation by the Tustin method [15], which is based on replacing all the terms s of the continuous transfer function with the expression of Equation (1), where T is the period of sampling [16]:

$$s = \frac{2}{T} \cdot \frac{1 - z^{-1}}{1 + z^{-1}} \quad (1)$$

For the output signal of the current process (See figure 5).

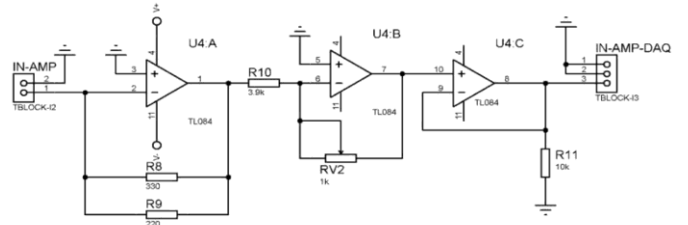

Fig. 5 Output conditioning circuit (4-20mA) to voltage

3) *Data acquisition stage*: Apart from having a low cost, this board has several analog and digital inputs and outputs as shown in the figure and also has a 32-bit counter. It generally

works as a system that digitizes input analog signals so that a computer can interpret them [17].

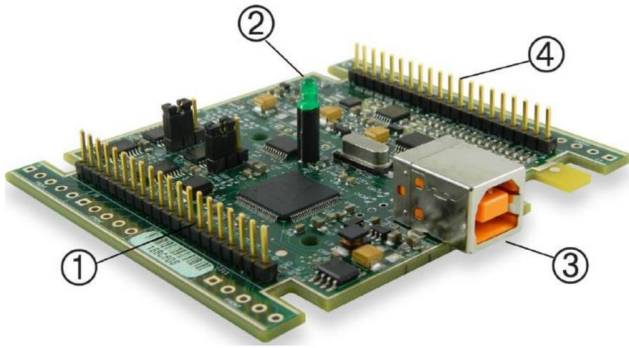

Fig. 6 OEM 1208FS USB DAQ Data Acquisition Card

4) *Single Stage Board Computer (Raspberry Pi 4 4GB):* The Raspberry Pi 4 is adopted in this work as the smart device with Raspbian open source operating systems. The written program is done using Python, with other Python libraries [18].

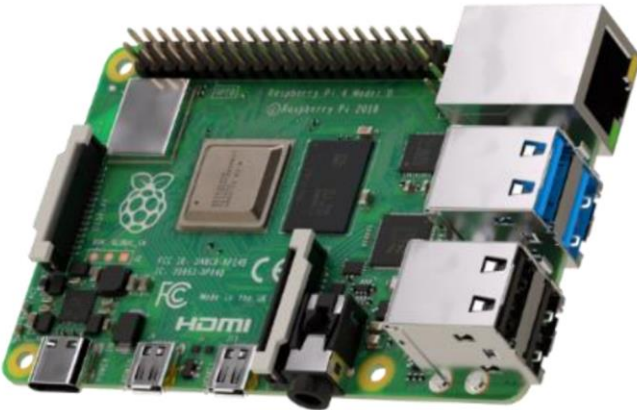

Fig. 7 Raspberry Pi 4 Model B+ 4GB

Below is the block diagram of the configuration and installation of the operating system, applications and updates of the single board computer.

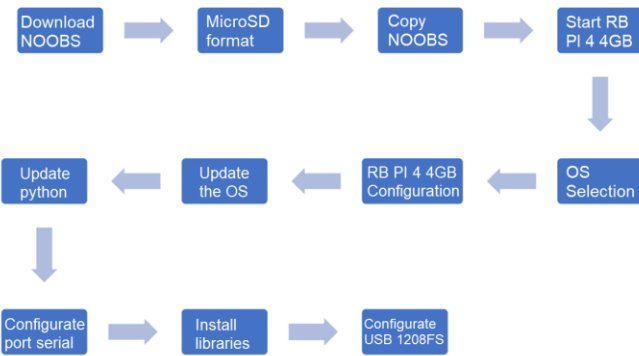

Fig. 8 Block diagram of configuration, library installation and updates

5) *Variable Identification Algorithm:* In order to carry out the calculation and show the graphs of the desired results, the following sequence of steps shown in figure x was carried out, starting with the libraries `usb_1208FS`, `scipy`, `numpy` `simpy`

and `math` to carry out the calculation of the vectors and all the mathematical part and `matplotlib` to visualize the identification system where the graphs and the identification results are shown, all programmed with the identification algorithm made in Python.

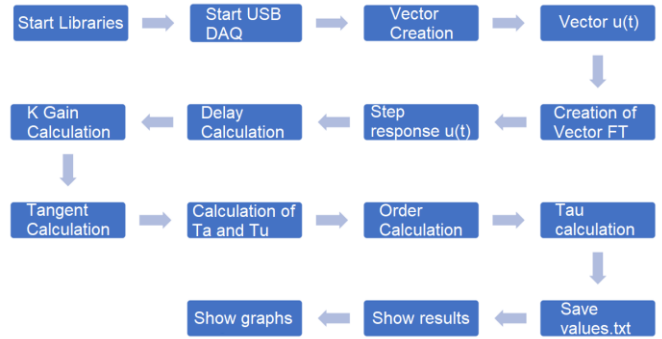

Fig. 9 Block Diagram of the Identification Algorithm

B. *System emulation stage*

1) *Input signal conditioning stage $u(t)$:* It was considered that in order to obtain the response of the system, it must be excited with an input signal $u(t)$, in this case it would be the signal of an industrial controller. In this sense, through the design of an electronic card, said signal is adapted to be captured by the data acquisition card, in order to excite the emulated transfer function and generate the output $y(t)$.

2) *Algorithm of the conditioning stage of the output signal $y(t)$:* Once the data (numerator and denominator coefficients) of the system to be emulated have been correctly entered or the plant identification process concluded successfully, everything is ready for the emulation process. Once the signal $u(t)$ is generated by the controller and is read by the data acquisition card through a signal conditioning stage, the system generates an output signal at voltage or current levels depending on the type of process. To emulate the entire process, the sampling time is also entered, as well as the end time of the emulation, below is the block diagram of the emulation algorithm.

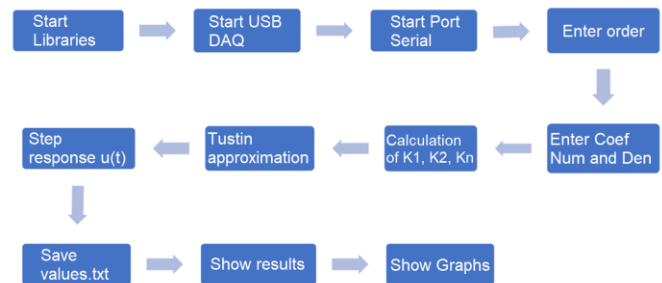

Fig. 10 Emulation algorithm block diagram

Touch screen 12.3" HDMI

The Raspberry Pi 4 presents the graphics of the system identification, emulation. Likewise, it will present various buttons and input commands for setting up and configuring the equipment's functionalities. All of this will be shown on a 12.3"-inch screen with touch features for ease of use by the user.



Fig. 11 Industrial Touch-Panel

III. RESULTS

Development of the identification algorithm of a SISO system up to Order 5, using open source software tools, the metrics for validation are as follows.

A. Development of Identification Algorithms

1) *Order 1*: Using the Matlab tool, the file primerOrden3ms.txt was generated, which has a sampling rate of 3ms and a total of 10,000 samples. The model elaborated by Matlab was the following

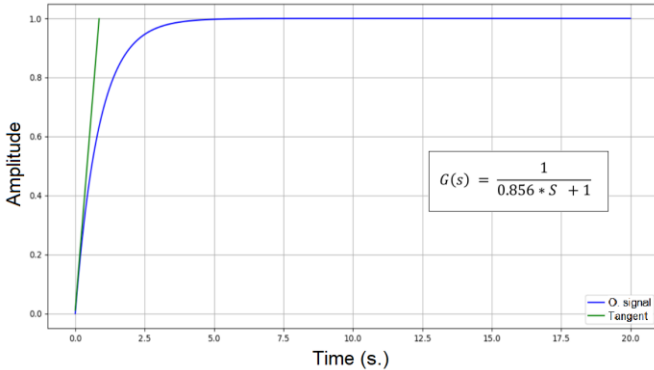
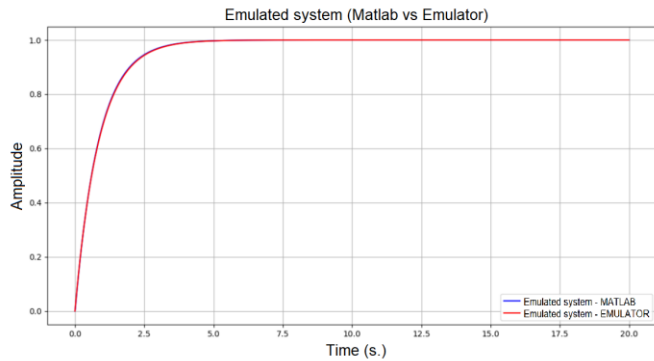

Fig. 12 Response to Step Order 1



Data number : 2000 MSE : 1.5320307550003483e-06

Fig. 13 Identified System of Order 1

With the results obtained after the identification process of an Order 1 system, a very small mean square error is shown in the results obtained.

2) *Order 2*: Using the Matlab tool, the file segundoOrden3ms.txt was generated, which has a sampling rate of 3ms and a total of 10,000 samples. The model developed by Matlab was the following.

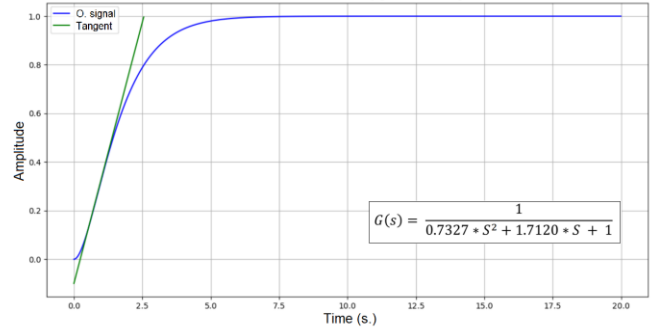
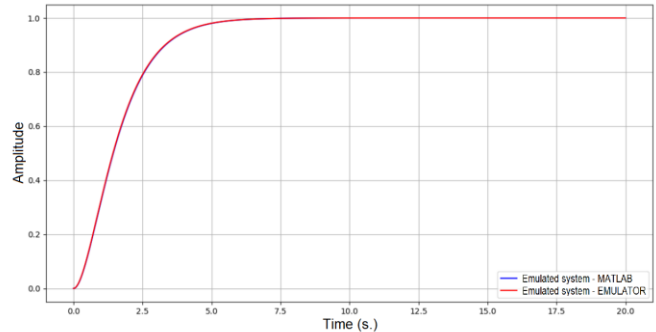

Fig. 14 Response to Step Order 2



Data number : 2000 MSE : 1.9482809400916138e-06

Fig. 15 Identified System of Order 2

With the results obtained after the identification process of an Order 2 system, a very small mean square error is shown in the results obtained.

3) *Order 3*: Using the Matlab tool, the file tercerOrden3ms.txt was generated, which has a sampling rate of 3ms and a total of 10,000 samples. The model developed by Matlab was the following.

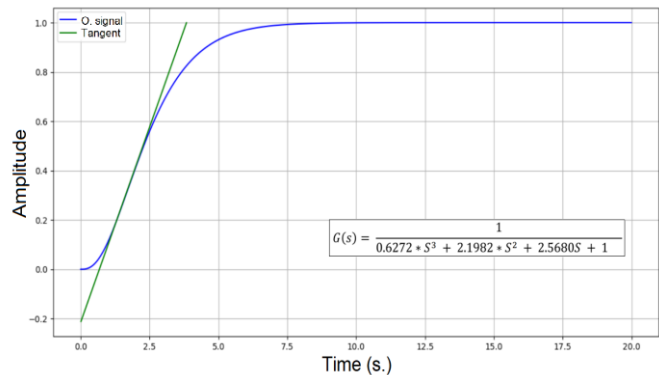
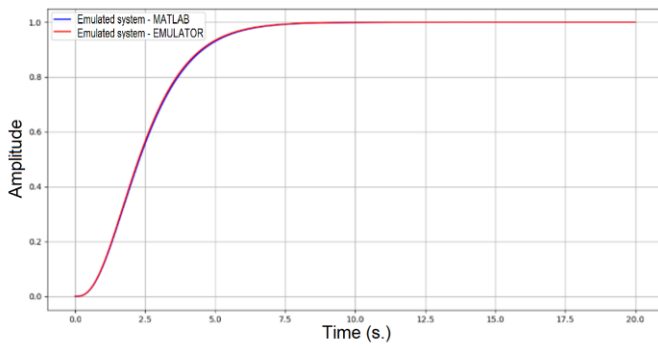

Fig. 16 Response to Step Order 3



Data number : 2000 MSE : 1.0005484383312472e-05

Fig. 17 Identified System of Order 3

With the results obtained after the identification process of an Order 3 system, a very small mean square error is shown in the results obtained.

4) Order 4: The following results were obtained.

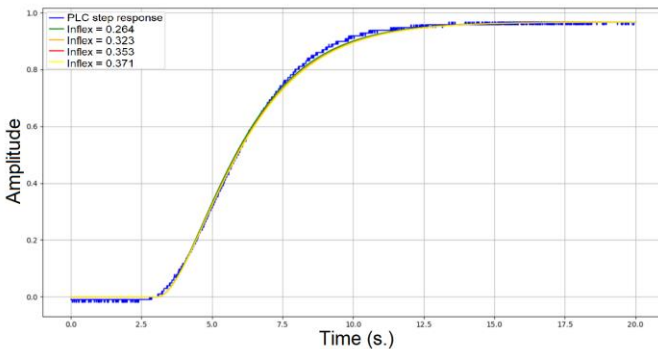

Data Number : 2000 MSE : 0.0000970596971026697

Fig. 18 Order System 4 Identified

With the results obtained after the identification process, it shows us that it is Order 2, but at the same time it shows a very small mean square error.

5) Order 5: The following results were obtained.

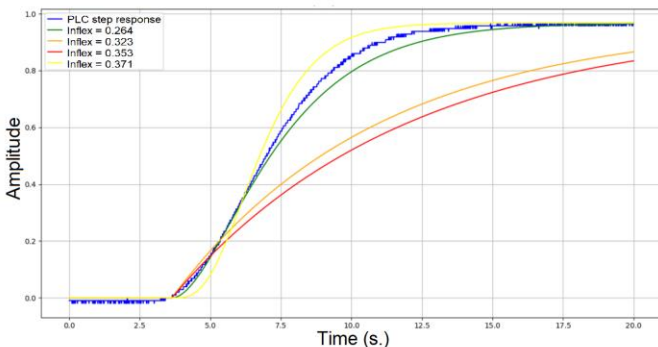

Data number : 2000 MSE : 0.000713667657743409

Fig. 19 Order System 5 Identified

B. Implement the algorithms in the embedded system

Models of order 1,2,3, 4 and 5 were entered one by one to the Embedded System, which every 10ms sends the data through an analog output to emulate the transfer function and is later observed on the oscilloscope.

1) Order 1:

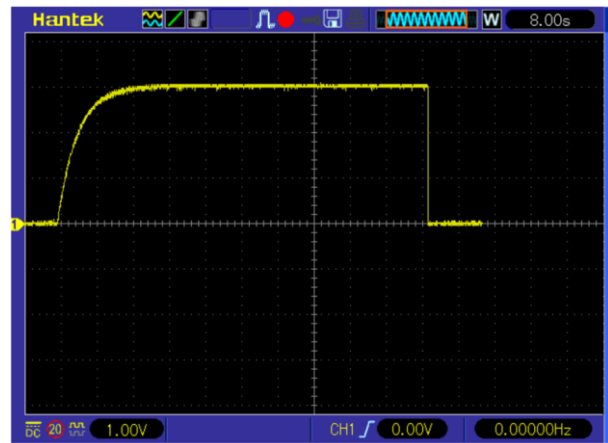

Data number: 2050 MSE : 0.000090836473234808

Fig. 20 Order System 1 emulated by the user

With the results obtained after the emulation process, a very small mean square error is shown.

2) Order 2:

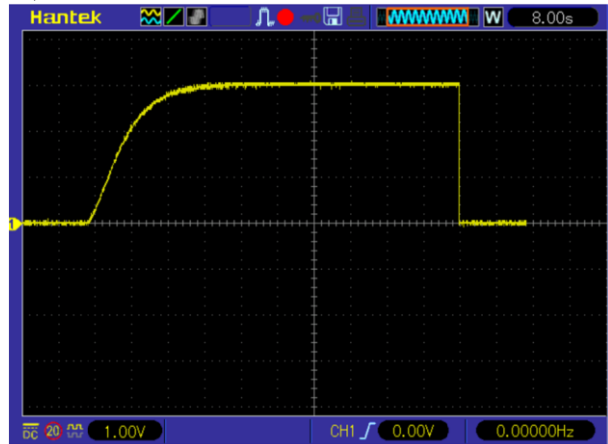

Data number: 2050 MSE : 0.000145815906423189

Fig. 21 Order System 2 emulated by the user

With the results obtained after the emulation process, a very small mean square error is shown.

3) Order 3:

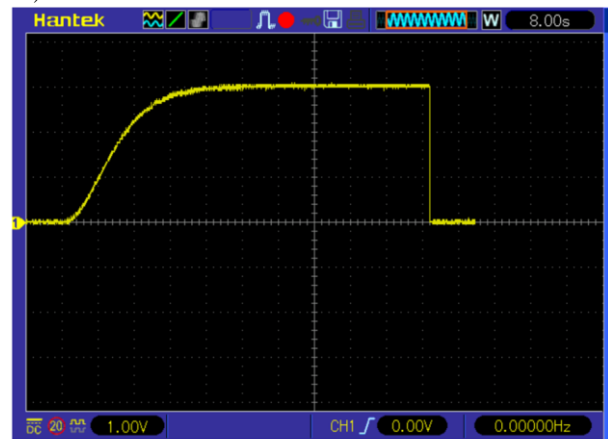

Data number: 2050 MSE : 0.000148321617069744

Fig. 22 Order System 3 emulated by the user

With the results obtained after the emulation process, a very small mean square error is shown.

4) Order 4:

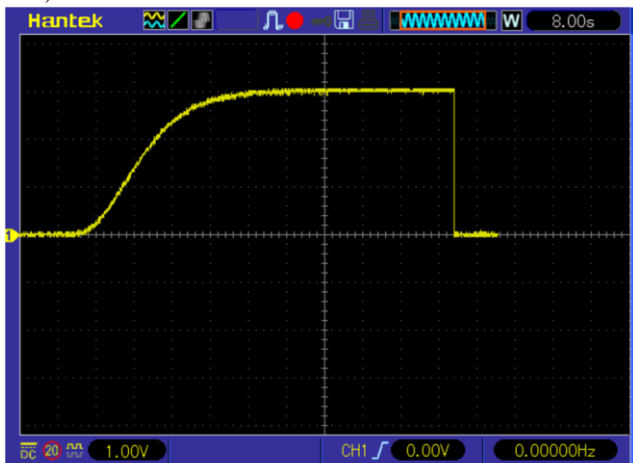

Data number: 2050 MSE : 0.000160818709170272

Fig. 23 Order System 4 emulated by the user

With the results obtained after the emulation process, a very small mean square error is shown.

5) Order 5:

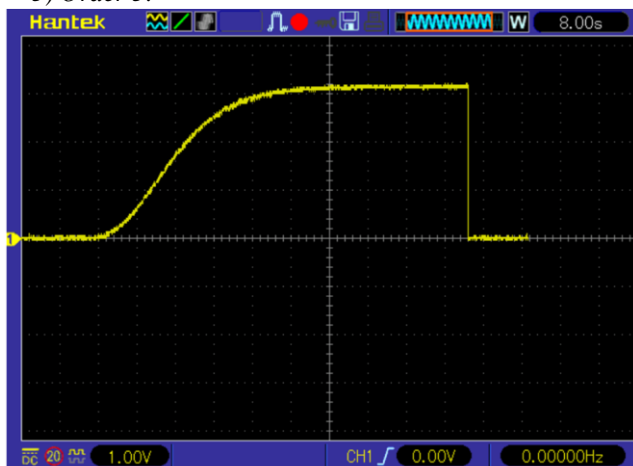

Data number: 2050 MSE : 0.000566840763194502

Fig. 24 Order System 5 emulated by the user

With the results obtained after the emulation process, a very small mean square error is shown.

III. CONCLUSIONS

For the development of the emulation algorithm of a SISO system up to Order 5 and making use of open source software tools, an approximation algorithm was implemented using the Tustin method, which showed a very low mean square error at the time of the emulation of a process. In the validation tests between the system emulated by Matlab and the one developed by our research, they also show very small error values.

A digital filter was implemented for the vector of samples of the system to be identified, where the identification of the system with a very low mean square error was demonstrated.

When making the identification, not only the order of the system must be evaluated, but also the level of similarity of the system to be identified. This is achieved by using the mean square error. Where in all cases of obtains very small values. When the Tustin algorithm was implemented in the embedded system, there were no problems with the emulated signal, its mean square error is very low. For the emulation process, it was verified that there is no need to do any additional treatment, the information was only sent through the analog output of the acquisition card.

III. RECOMENDATIONS

It is recommended for future investigations to have a sampling time of up to 1ms, with the intention of being able to emulate systems or processes with faster reaction response times.

It is recommended for the identification process to have a greater variety of digital filters with the intention of making a better treatment of the signal. For environments with a lot of electrical noise, the use of very low noise sources, or the use of batteries for identification power.

REFERENCES

- [1] E. Tlachi Cuanenem, "Algoritmo De Control Predictivoaplicado a El Control De Nivel De Liquido De Un Sistemade 4 Tanques Acoplados," BENEMERITA UNIVERSIDAD AUTÓNOMA DE PUEBLA, 2018.
- [2] I. Hernández Baez, "Diseño y simulación de un sistema didáctico para prueba de algoritmos de control en un arreglo hidráulico de cuatro tanques con acoplamiento cruzado," Benemérita Universidad Autónoma De Puebla, 2013.
- [3] Munadi and M. A. Akbar, "Simulation of fuzzy logic control for DC servo motor using Arduino based on MATLAB/Simulink," *Proc. 2014 Int. Conf. Intell. Auton. Agents, Networks Syst. Ina. 2014*, pp. 42–46, 2015. DOI: 10.1109/INAGENTSYS.2014.7005723.
- [4] J. Mohammed, "Control of a Ball and Plate System Using Model-Based Controllers," Palestine Polytechnic University, 2020.
- [5] N. D. B. K. Ashar, Z. M. Yusoff, N. Ismail, and M. A. Hairuddin, "ARX model identification for the real-time temperature process with Matlab-arduino implementation," *ICIC Express Lett.*, vol. 14, no. 2, pp. 103–111, 2020. DOI: 10.24507/icicel.14.02.103.
- [6] E. Bedriñana Enciso, "MODELAMIENTO DE LA VALVULA DE CONTROL TECNOCRAF 202316 PARA LA INCUBADORA NEONATAL," Pontificia universidad católica del Perú, 2011.
- [7] G. Aquino Mendieta, "Automatización de la Secuencia de Operación de una Máquina para Ensayos de Torsión en Caliente," Instituto Politécnico Nacional, 2012.
- [8] D. A. Valenzuela Nilo, "Comparación de técnicas de control predictivo para un convertidor matricial indirecto con minimización de potencia reactiva, aplicado a un sistema multidrive compuesto por dos motores de inducción," Universidad de Chile, 2022.
- [9] F. Carrillo Urcid, "Implementación De Un Sistema Que Emule La Generación De Energía Fotovoltaica Con Operación En Modo Isla Y En Modo Red," Instituto Politécnico Nacional, 2017.
- [10] L. A. Sanchez Carlos and D. A. Cruz Irigoin, "Diseño E Implementación De Un Modulo Didáctico De Control De Temperatura Para La Escuela Profesional De Ingeniería Electrónica En La Unprg," Universidad Nacional Pedro Ruiz Gallo, 2018.

- [11]E. Velo Sanchez, “Desarrollo y Testeo de un Emulador de Plantas Industriales Basado en Arduino,” Universidade da Coruña, 2014.
- [12]M. Olivares Ávila and J. Gallardo Arancibia, “Identificación de sistemas siso lti a partir de su definición matemática,” Universidad de Atacama, 2016.
- [13]P. J. Pabón Lopez, “DISEÑO Y CONSTRUCCIÓN DE UN EQUIPO AUTOMATIZADO PARA PRÁCTICAS DE FLEXIÓN DE VIGAS PARA EL LABORATORIO DE MECÁNICA DE MATERIALES DE LA UNIVERSIDAD DE LAS FUERZAS ARMADAS-ESPE,” Universidad de las Fuerzas Armadas -ESPE, 2021.
- [14]S. A. Aguilar Saquicela, “Implementación de un Sistema de Control Automático de Temperatura para la Máquina Corrugadora de la Industria Cartonera ‘INCARPALM,’” ESCUELA SUPERIOR POLITECNICA DE CHIMBORAZO, 2016.
- [15]L. A. Bermeo Varon, J. G. Alvarez, and W. Mantilla Arenas, “Comparación del desempeño de un controlador PID sobre el proceso de nivel usando un controlador lógico programable y un sistema embebido,” *Ingeniare. Rev. Chil. Ing.*, vol. 29, no. 4, pp. 622–632, 2021. DOI: 10.4067/s0718-33052021000400622.
- [16]C. Higuera Arias and E. C. Camacho Poveda, “Evaluación de Desempeño de Controladores para Regulación de Temperatura y Nivel en Tanques en Cascada,” Universidad Pedagógica y Tecnológica de Colombia, 2014.
- [17]J. E. Jaramillo Ruiz, “MOUSE PARA PERSONAS CON DISCAPACIDAD EN SUS EXTREMIDADES SUPERIORES CONTROLADO POR MEDIO DE MOVIMIENTOS DE CABEZA Y GESTOS,” Universidad Técnica de Ambato, 2016.
- [18]M. Zuma, P. A. Owolawi, V. Malele, K. Odeyemi, G. Aiyetoro, and J. S. Ojo, “Intrusion Detection System using Raspberry Pi and Telegram Integration,” pp. 1–7, 2021. DOI: 10.1145/3487923.3487928.