



Clustering Distribution Islands with DERs for Limited System Restoration

Diego Aponte-Roa¹ , PhD, Chee-Wooi Ten² , PhD, Wayne W. Weaver² , PhD



¹Universidad Ana G. Méndez, Puerto Rico, aponted1@uagm.edu

²Michigan Technological University, United States, ten@mtu.edu, wwweaver@mtu.edu

Abstract—When a major outage has occurred in an area with constant disruptive storms, a coordinated decision to safely restore power in the region is critical in the recovery efforts. However, the certainty of grid status can be hard to predict, especially determining if a communication infrastructure is devastated. In this paper, characterizing the potential restoration likelihood is formulated based on a generalization of the restoration process. Such cluster of restorative methodology is proposed as a decision tool for power service restoration. The milestone captures models of transitions, probabilistic estimation, and statuses for generic power system components that are developed to establish the network behavior. Multiple test scenarios have been developed to validate the proposed methodology. Results indicate that after a catastrophic event, the proposed approach can suggest the steps for the switching sequence of the T&D system during the grid recovery process based on the power monitoring devices. This approach can be integrated as a planning tool for grid planning.

Index Terms—Distribution system, generalized stochastic Petri net, grid island, Bottom-up restoration

Clustering Distribution Islands with DERs for Limited System Restoration

Diego Aponte-Roa¹ , PhD, Chee-Wooi Ten² , PhD, Wayne W. Weaver² , PhD

¹Universidad Ana G. Méndez, Puerto Rico, aponted1@uagm.edu

²Michigan Technological University, United States, ten@mtu.edu, wwweaver@mtu.edu

Abstract—When a major outage has occurred in an area with constant disruptive storms, a coordinated decision to safely restore power in the region is critical in the recovery efforts. However, the certainty of grid status can be hard to predict, especially determining if a communication infrastructure is devastated. In this paper, characterizing the potential restoration likelihood is formulated based on a generalization of the restoration process. Such cluster of restorative methodology is proposed as a decision tool for power service restoration. The milestone captures models of transitions, probabilistic estimation, and statuses for generic power system components that are developed to establish the network behavior. Multiple test scenarios have been developed to validate the proposed methodology. Results indicate that after a catastrophic event, the proposed approach can suggest the steps for the switching sequence of the T&D system during the grid recovery process based on the power monitoring devices. This approach can be integrated as a planning tool for grid planning.

Index Terms—Distribution system, generalized stochastic Petri net, grid island, Bottom-up restoration

I. INTRODUCTION

IN power system planning, extreme power outage related to a major storm can be challenging to predict. Large power outages are expected in the aftermath of an extreme weather event if the storm “walks” through the area which can delay the recovery efforts [1], [2]. The primary supply of power from the transmission grid might not be available and identifying power supply possibilities at the distribution level based on its availability by participating consumers might provide temporary power to the critical loads locally or regionally while primary supply is recovered.

In distribution planning, the infrastructural expansion in meeting with the adequacy of electrical demand with Distributed Energy Resources (DERs) and sensing technologies is on the horizon. However, budgetary investment is often limited and constrained to operational and safety limits. Reconfiguration in distribution feeders can be enhanced with normally open (NO) switches which enable the possibility to receive power from other sources, such as other substations or feeders under the same substation [3]. These switches are strategically surveyed for investment optimally [4], [5].

There has been a national push to improve system resilience. A disrupted infrastructure should provide robust reconfigurable

paths that can rapidly restore power from mainstream or DERs to make power temporarily available for critical services in the aftermath of a disaster. This paper proposes a systematic methodology which includes load priority, DG location, and transitions priorities, to restore power in the aftermath of catastrophic devastation resulting a complete blackout. The organization of this paper is as follows. Section II describes discrete event modeling for clustering generation and loads adequately. Section III discusses the proposed restoration approach. Section IV provides several test case scenarios and result analysis. Finally, Section V is a summary and conclusions.

II. DISCRETE EVENT MODELING

This section provides an establishment of restorative models that captures the events with a eight-tuple structure integrating elements $P, T, \Gamma, I, O, H, M_O$, and Λ [6], [7]. Specifically, the P, T, I, O, M_O are the basic underlying PNs such as $P : \{P_1, P_2, \dots, P_m\}$ defines the place node, $T : \{T_1, T_2, \dots, T_n\}$ defines the transition node, I is a set of input arcs such as $I \subset P \times T$, O is a set of output arcs such as $O \subset T \times P$, and $M_O : \{m_{O1}, m_{O2}, \dots, m_{Om}\}$ is an initial marking.

An assignment of priorities to transitions, Γ , which associates lowest priority (0) with timed transitions and higher priorities (≥ 1) with immediate transitions, H is a set of inhibitor arcs such as $H \subset P \times T$, and $\Lambda : \{\lambda_1, \lambda_2, \dots, \lambda_n\}$ is an array of firing rates associated with transitions (a firing delay is associated with each transition).

Tokens (black dot) are assigned to places, and a distribution of tokens in the places represents a state of the system, whereas transitions model events or activities for transitioning from one status to another presented in Fig. 1). A transition will “fire” only when there are tokens that also enabled by its corresponding input place and will add a token to output places when inputs are provided. Each token residing in places has some data value associated with it.

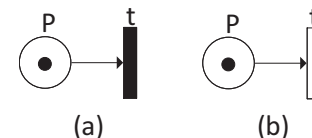

Fig. 1. GSPN notations for transitions. (a) immediate transition. (b) timed transition.

Digital Object Identifier: (only for full papers, inserted by LACCEI).
ISSN, ISBN: (to be inserted by LACCEI).
DO NOT REMOVE

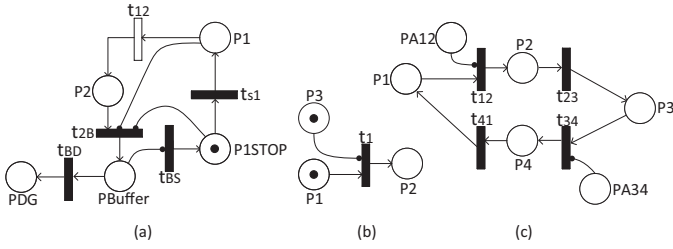

Fig. 2. Power Components PN Models. (a) DG model. (b) Load model. (c) Power line model.

A. Distribution System Components Equivalent PN Models

The diesel generator (DG) and/or the pole availability depends of the signal received from the Remote Terminal Unit (RTU) connected with p1STOP referred in Fig. 2. For Fig. 2(a) a token in P1 correspond to DG is in mode 1 (off-state - no power production) while a token in P2 represent that DG is in mode 2 (on-state - providing power). Token in pBuffer shows a normal power transfer operation between DG and power distribution grid PDG. ts1, t2B, tBD, and tBS are all immediate transitions while t12 is a timed transition required to start DG operation. t2B have two inhibitors due to no power production or a fault that require stop of operation, and tBS has one inhibitor correspond to a STOP request for generator. PDG indicates that generator is ready to dispatch its rated capacity when it receives a token on the firing of transition tBD (which indicates the switch ON position of a generator). Firing of tBD, in turn, happens when pBuffer hold at least a token. Initially, P2 holds a token of value equal to the rated capacity of generator because at the time of starting no loads are picked up and, hence, the generator has rated capacity which is unused.

For Fig. 2(b) a token in P1 indicates the load priority, which is considered when more than one load bus is ready to get connected. A token in P2 means that load has been picked up while P3 indicates the load interfacing point with the distribution line. Having a token in P3 indicates that all associated lines are now alive (when RTU receives a signal).

Places P1 and P2 in Fig. 2(c) are the two terminals of a power line. A token in P1 or P3 indicates the line is active. PA12 and PA34 controls the limiting line capacity flow as well as the direction of flow. Marking of place P2 and P4 indicates flow direction from P1 to P3 and P3 to P1, respectively. Transitions t12 and t41 have one inhibitor due to the maximum capacity of the distribution line in each direction. Initially, markings of place PA12 and PA34 are the maximum capacity of the distribution line in each direction.

B. Power Facilities Equivalent PN Models

Power facilities could have or not Black Start Units (BSU). Power facility and/or the pole availability also depends of the signal received from the RTU connected with p1STOP referred in Fig. 3. For Fig. 3(a) a token in P1 correspond to utility is in mode 1 (off-state - no power production) while a token in P2 represent that utility is in mode 2 (on-state -

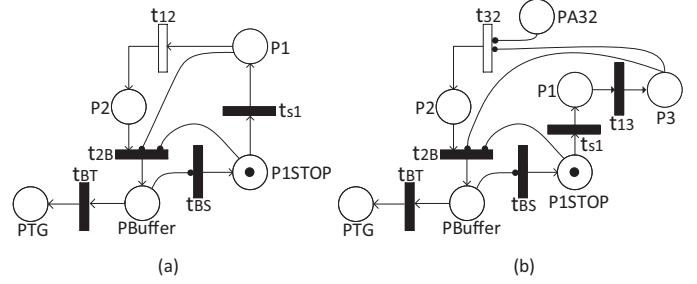

Fig. 3. Power Facilities PN Models. (a) Facilities with BSU. (b) Facilities without BSU.

providing power). Token in pBuffer shows a normal power transfer operation between utility and power transmission grid ptG through its main transformer. ts1, t2B, tBT, and tBS are all immediate transitions while t12 is a timed transition required to start utility operation. t2B have two inhibitors due to no power production or a fault that require stop of operation. tBS has one inhibitor correspond to a STOP request for utility.

For Fig. 3(b) P1 and P2 corresponding to utility mode 1 and mode 2 as well. A token in P3 represents that utility is in mode 3 (transition to on-state - consuming power). ts1, t13, t2B, tBT, and tBS are all immediate transitions while t32 is a timed transition required to start utility operation and has one inhibitor representing Cranking availability. t2B have two inhibitors due to no power production or a fault that require stop of operation, and tBS has one inhibitor correspond to a STOP request for utility.

For both models, pTG indicates that facility is ready to dispatch its rated capacity when it receives a token on the firing of transition tBT. Firing of tBT, in turn, happens when pBuffer hold at least a token. Initially, p2 holds a token of value equal to the rated capacity of facility because at the time of starting no loads are picked up and, hence, the facility has rated capacity which is unused.

C. Additional Power System Components Equivalent PN Models

Breakers and Switches have two possible states: On or Off. Power transformers is also modeled by two states: Energized or De-energized. Its PN representation is shown in Fig. 4. P1 correspond to off/de-energized state while a token in P2 represent a on/energized state. Token in pBuffer shows a normal operation on the transformer or a close state on switch/breaker. tB1 and t2B are immediate transitions while t12 is a timed transition required to start transformer operation or to change switch state. tB1 has one inhibitor correspond to a switch/transformer change of state.

D. Network Topology After Disaster Using PN

In a radial system, any of the RTUs located on the radial feeder giving any MW information indicates that the whole feeder is alive. In this paper, logic gates in PN is used for determining the active aliveness of the power line by using

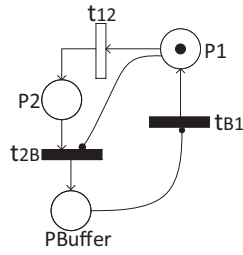

Fig. 4. Switch, Breaker, and Power Transformer PN Model.

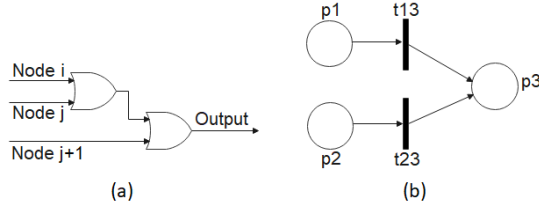

Fig. 5. (a) Logic gate representation for determining the aliveness of power line. (b) PN model of an OR gate.

the digital information obtained from RTUs when the communication link is down but power links or any other power system components are alive. This approach was presented in [8] and the logic PN representation is shown in Fig. 5. Equation (1) is obtained from Fig. 5, which is OR summation of the status of the nodes of the network

$$\text{Output} = \sum_{l \in i,j}^n \text{line } l = \begin{cases} 1 & \text{node } i \text{ or } j \text{ active for power flow} \\ 0 & \text{node } i, j \text{ not active for power flow} \end{cases} \quad (1)$$

where i and j denote the receiving and outgoing node of the power line whose aliveness is being checked, n is the total number of lines of the system, and output is the OR summation of information obtained (in binary format) from RTUs installed at different bus bars of the feeder.

When communication link is active but power links or other components are down, a presence of token in the place node of equivalent PN diagram indicating binary digit “1” for active power lines or other components is expected. Then, after the restrictions are verified (presented in section III-A), the token is moved if two buses and their connecting line is intact.

III. RESTORATION APPROACH

Although the global objective in a network recovery must be reconnect the major amount of loads to the electric distribution network, critical loads are the decision-making factors.

A. Restoration Constraints

During the restore effort each DG will start to support local loads only with a higher priority the critical loads. A binary variable $v_i^k = \{0, 1\}$ is assigned to each node such as: if node i is restored using DER k then $v_i^k = 1$, otherwise, it is 0. Constraints (2)–(4) ensure that the restored networks are connected and operate in radial topology. In addition,

constraints (5)–(6) define the desired operational attributes.

$$v_i^k = 1, i = k, \forall k \in V_s \quad (2)$$

$$\sum_{k \in V_s} v_i^k \leq 1, \forall i \notin C_l \quad (3)$$

$$\sum_{k \in V_s} v_i^k = r_i, \forall i \in C_l \quad (4)$$

$$0.95 \times v_i^k \leq V_i^k \leq 1.05 \times v_i^k, \forall i \in V, \forall k \in V_s \quad (5)$$

$$\sum_{i=1}^{n(V)} v_i^k P_i \leq P_{max}^k \text{ and } \sum_{i=1}^{n(V)} v_i^k Q_i \leq Q_{max}^k, \forall k \in V_s \quad (6)$$

B. General Purpose Petri Net Simulator (GPenSIM)

In this paper, GPenSIM is used for power service restoration purpose. GPenSIM tool runs on MATLAB platform [9]. Timed Petri Nets are used to modeling the time required to do a task. Therefore, all the transitions are considered to have finite (non-zero) firing times.

For modeling in GPenSIM, three main files are required: 1) Petri net Definition File (PDF), 2) Transition Definition Files (TDF), and 3) Main Simulation File (MSF). The PDF has the static details of a Petri net graph. The corresponding Petri net graph of a electrical power system can be constructed from their incidence matrix under normal condition. This matrix can be generated using the Geographic Information System data of a desired power system on a region [10]. The MSF contains the dynamic information (such as initial tokens in places, firing times of transitions) of the Petri net. This information is obtained from the updated incidence matrix and the network topology using information provided by the control room. TDF contains all the firing conditions (as the restoration constraints) and actions to take after a certain transition completes firing.

C. Token movement

The sequential movements of token across the nodes occur according to the following set of rules and assumptions:

1. Distribution circuit is equipped with enough Remote Control Systems as needed.
3. It is assumed that a line is damaged when at least a pole at that line is damaged and remains damaged until it is repaired.
4. For maintaining radial power flow, a single DG energizes only one section of the distribution network.
5. To ensure that available DG first are used to serve critical loads, the weighting factor of a critical load should be sufficiently greater than that of a non-critical one.
6. Voltage and power flow constraints have been satisfied in PN modeling through arc expressions.

IV. RESULTS AND DISCUSSION

Fig. 6 shows the one-line diagram of a 7-node radial distribution feeder used to generate different test case studies. Simulations were performed in the GPenSIM tool software following switching action which are defined by functions attached to the arcs. The PN equivalent model of the composite system is shown in Fig. 7.

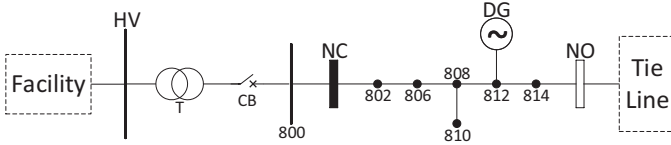

Fig. 6. One-line diagram of the testing power system.

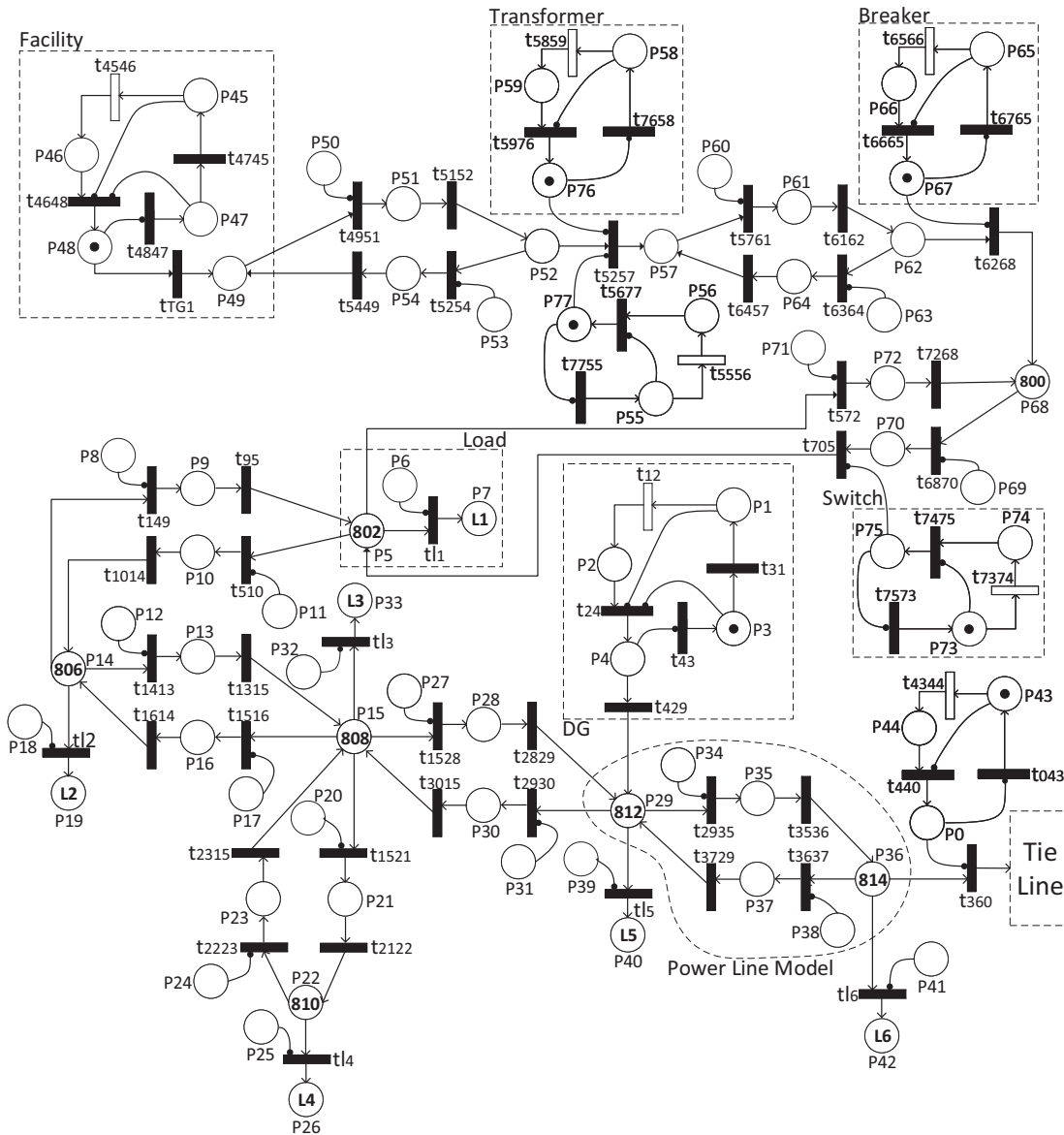

Fig. 7. PN equivalent model of the testing power system.

A. Case 1: 7-Node Feeder with Transmission Network not Available

This case illustrates how the distribution system aids recovery efforts even if the transmission network is unavailable due to several damages in either the transmission lines or power facilities. A DG is located in node 812 for system recovery at distribution level. In addition, 6 lumped loads are included in Nodes 802 to 814. Node 800 is representing the substation transformer serving this feeder. Scenario 1 assume that timed transition t12 is deterministic and require 1 time unit value to start DG operation, while scenarios 2 to 5 assume this transition as stochastic.

1) *Scenario 1: 7-Node Feeder Restoration under Normal Circumstances:* This scenario assumes that all distribution lines are active and the DG can support the full load demand

of the feeder. For restoration purposes, loads are assumed with equal magnitude and priority. The switching sequence of the token flow and the load restoration is presented in Fig. 8. Results shows that all the loads were recovered.

2) *Scenario 2: 7-Node Feeder Restoration under Normal Circumstances with Stochastic Firing Times:* This scenario is similar to scenario 1, however, in real life systems all the firing times are stochastic. Then, timed transition t12 takes random time uniformly distributed with min 1 and max 2 time units representing the time required for start the DG operation. The switching sequence of the token flow and the load restoration is presented in Fig. 9. Results shows that all the loads were also recovered but with an expected delay (between 1 to 2 time units) due to the timed transition t12.

3) *Scenario 3: 7-Node Feeder Restoration under Normal Circumstances with Load Priority:* This scenario is similar to scenario 2 but a highest priority is assigned to a load. The switching sequence and the loads restoration for both L2 (P19) and L4 (P26) assigned with a highest load priority are presented in Fig. 10 and Fig. 11, respectively. Results shows that all the loads were also recovered but load with a highest priority was picked up first.

4) *Scenario 4: 7-Node Feeder Restoration based on Lines Availability:* This scenario is similar to scenario 3 but it is assumed that after a disaster condition, the lines connecting nodes 802-806 suffered catastrophic damages and it will not available. The switching sequence and the loads restoration for both L2 (P19) and L4 (P26) assigned with a highest load priority are presented in Fig. 12 and Fig. 13, respectively. Results shows that load connected to node 802 (L1) cannot be restored. All other loads were recovered but load with a highest priority was picked up first.

5) *Scenario 5: 7-Node Feeder Restoration based on Lines Recovery Time:* This scenario is the similar to scenario 4 where the lines connecting nodes 802-806 are not available, however, for this scenario damages are not catastrophic and

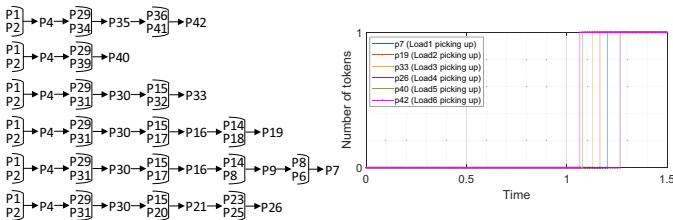

Fig. 8. 7-Node feeder restoration under normal circumstances.

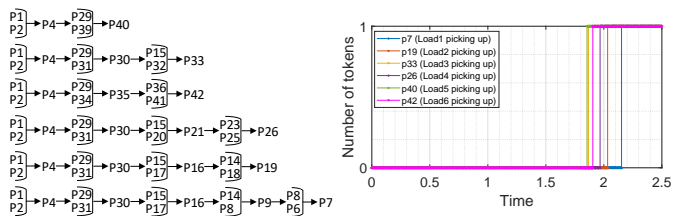

Fig. 9. 7-Node feeder restoration under normal circumstances with stochastic firing times.

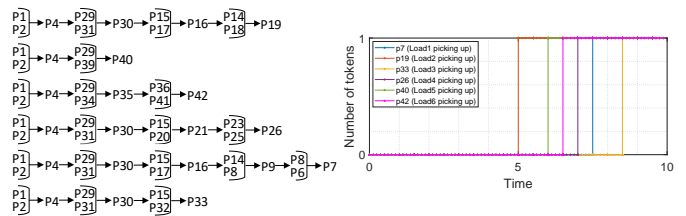

Fig. 10. 7-Node feeder restoration with load priority assigned to L2

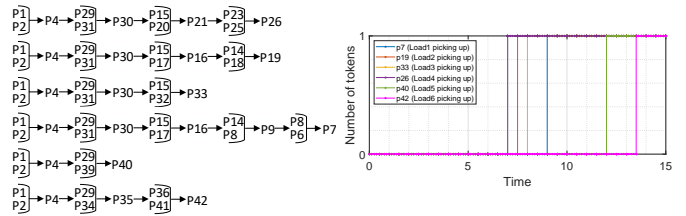

Fig. 11. 7-Node feeder restoration with load priority assigned to L4

lines are expected to be recovery in a reasonable time. Then, the affected line recovery time is modeling through a random time uniformly distributed between 10 to 20 time units.

The switching sequence and the loads restoration for both L2 (P19) and L4 (P26) assigned with a highest load priority are presented in Fig. 14 and Fig. 15, respectively. Results shows that load connected to node 802 (Load 1) cannot be temporarily restored and the other six loads were recovered but load with a highest priority was picked up first. As expected, after 10 to 20 time units lines connecting nodes 802-806 was recovery and Load 1 was successfully restored.

B. Case 2: 7-Node Feeder Recovery with Transmission Network Available

This case is presented to illustrate how the reduced testing power system showed in Fig. 6 restore the loads. This scenario assumes that all T&D lines are active and the facility can

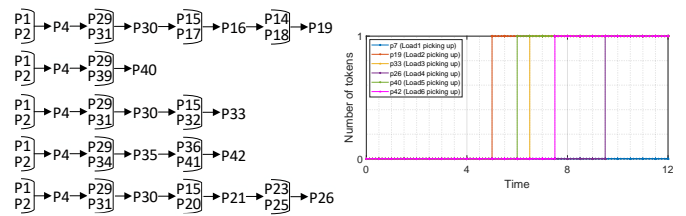

Fig. 12. 7-Node feeder restoration based on lines availability with load priority assigned to L2

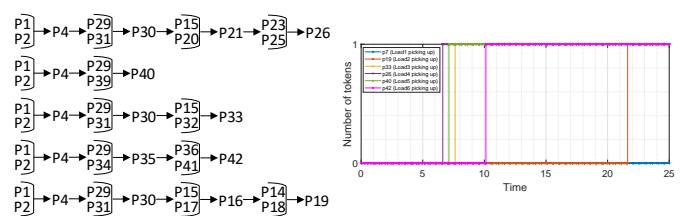

Fig. 13. 7-Node feeder restoration based on lines availability with load priority assigned to L4

